

Granit IP65 0-10V 31000lm 865 WB

Item No: 0039603

SYLVANIA



Integrated LED highbay; Black aluminium housing; 30400Lm; 220 W; 138 Lm/W; 6500K; Drive current: 860mA; CRI 80; 85° beam angle; 0-10V dimmable; IP65; IK08; Lifespan L80:B50 90,000 hrs; (D x H) 385 x 181 mm; 1.5 m mains cable; 1.5 m control cable; 1.2 m chain length including hooks.

Technical Assets

Dimensions (mm)

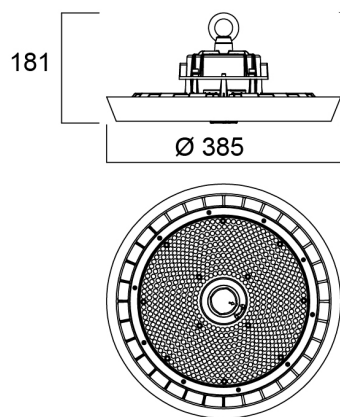

Photometrics

Distance [m]	Cone diameter [m]	Beam diameter [m]	Beam diameter [ft]	Beam diameter [in]	Illuminance [lx]
0.5	0.86	0.71	2.33	9.21	8546
1.0	1.72	1.42	4.66	18.42	2137
1.5	2.58	2.13	7.00	27.64	905
2.0	3.44	2.84	9.33	36.85	537
2.5	4.30	3.55	11.66	46.06	342
3.0	5.16	4.26	13.99	55.27	226

Distance [m] Cone diameter [m] Illuminance [lx]
 CO - C180 (Half beam angle: 81.4°)

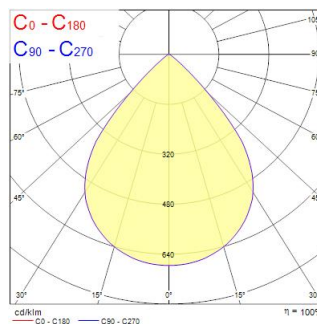

Granit IP65 0-10V 31000lm 865 WB

Item No: 0039603

SYLVANIA

General data

Product name	Granit IP65 0-10V 31000lm 865 WB
Technology	LED
Housing	Aluminium
Mount	Suspended
Fixture rating	Enclosed
General application	Logistics & Industry
Operating temperature range (°C)	-30°C...+50°C
Performance ambient temperature Tq (°C)	25
ETIM Class	EC001716
E-number FI	4357013
Warranty	5 years

Optical data

Fixture luminous flux (lm)	30400
Luminaire efficacy (lm/W)	138
Correlated colour temperature (k)	6500
Light colour	Cool White
CRI (Ra)	80
Colour Variation Initial (SDCM)	SDCM3
Beam Angle (°)	85
Glare control	< 25
Photobiological Risk Group	RG1

Electrical data

Total power consumption (W)	220
Lamp power factor	1
THD (at 230 V, 50 Hz, full load, at 100% dimming level) ≤ xx.x %	10
Electrical protection	Class I
Dimmable	Yes
Dimming method	0-10V
Drive current (mA)	860
Inrush Current (A)	99.2
Inrush Duration (µs)	220
Energy Efficiency Class (A->G) of contained light source	E
Nominal Frequency (Hz)	50/60Hz
LED Flickering Rate	Ultra low (5% or less)
Max. products per 10A C Breaker	6
Max. products per 13A C Breaker	8
Max. products per 16A C Breaker	10
Max. products per 20A C Breaker	13
Max. products per 10A B Breaker	4
Max. products per 13A B Breaker	5
Max. products per 16A B Breaker	6
Max. products per 20A B Breaker	8

Lifetime data

Lifespan L80 B50	90000
Lifespan L80 B20	70000
Lifespan L80 B10	65000
Lifespan L90 B50	45000

Granit IP65 0-10V 31000lm 865 WB

Item No: 0039603

SYLVANIA

Physical data

Housing colour	Black
IP rating	IP65
IK rating	IK08
Diffuser finish	Transparent
Diffuser material	PC Polycarbonate
Nominal Product Length (mm)	385
Nominal Product Width (mm)	385
Nominal Product Height (mm)	181
Nominal Product Diameter (mm)	385
Weight (kg)	4.77

Packaging

Product EAN number	5410288396033
Packaging single length / height (cm)	44.5
Packaging single width (cm)	44.5
Packaging single depth (cm)	19.5
DUN14 (inner)	05410288396033
Units per outer package	1
Packaging outer length / height (cm)	44.5
Packaging outer width (cm)	44.5
Packaging outer depth (cm)	19.5

Safety data

Glow Wire Test (°C)	850
Optimal operating condition (°C)	-30-50