

QR-CB51 50W GU/GX5.3

Item No: 3035840



Technical Assets

Dimensions (mm)

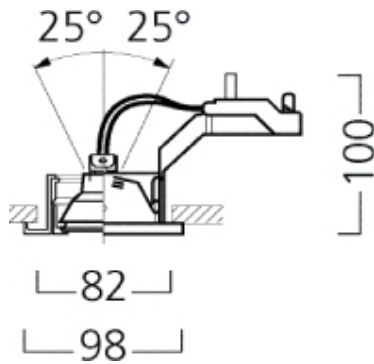

Photometrics

Distance [m]	Core diameter [m]	Illuminance [lx]
0.5	0.07	9600 8300
1.0	0.14	4104 3576
1.5	0.22	1851 1620
2.0	0.29	1041 910
2.5	0.36	606 528
3.0	0.43	453 396

Distance [m] Core diameter [m] Illuminance [lx]
 C0 - C180 (Half beam angle: 8.2°)

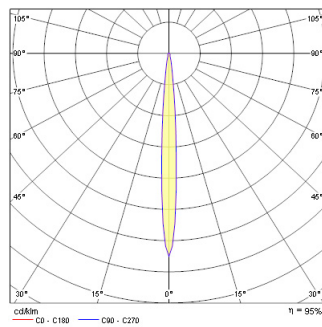

QR-CB51 50W GU/GX5.3

Item No: 3035840

General data

Product name	QR-CB51 50W GU/GX5.3
Mount	Ceiling recessed mounting
Environment	Interior
General application	Hospitality, Office
E-number FI	4277576
E-number SE	7472746

Optical data

Adjustable chromaticity	N
Distribution type	Adjustable

Electrical data

Electrical protection	Class III
Control gear mounting	Remote

Physical data

Housing colour	Aluminium
IP rating	IP20
Weight (kg)	0.6

Packaging

Product EAN number	8711971358404
Packaging single width (cm)	12.0
Packaging single depth (cm)	11.0
Packaging outer length / height (cm)	23.0

Safety data

Glow Wire Test (°C)	850
---------------------	-----