

Brushed Chrome Bezel 295

Item No: 0053436

SYLVANIA

START

CE UK
CA



Brushed Chrome bezel as an optional accessory for START eco Downlight 5in1 (compatible SKUs of 0053415, 0053416). Can be attached to the product in a few seconds with the help of the magnetic design.

Technical Assets

Dimensions (mm)

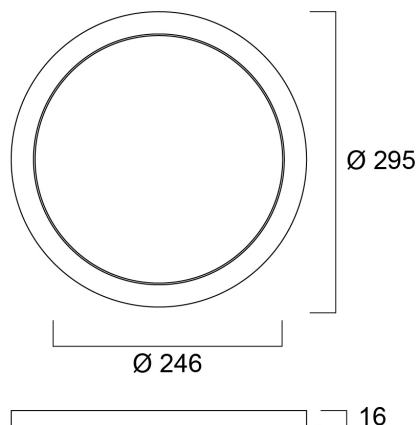

Photometrics

General data

Product name	Brushed Chrome Bezel 295
Technology	Accessory
General application	Residential & Consumer
ETIM Class	EC002557
E-number FI	4278107
Warranty	3 years

Physical data

Nominal Product Length (mm)	295
Nominal Product Width (mm)	295
Nominal Product Height (mm)	16
Weight (kg)	0.17

Brushed Chrome Bezel 295

Item No: 0053436



Packaging

Product EAN number	5410288534367
Packaging single length / height (cm)	29.9
Packaging single width (cm)	29.9
Packaging single depth (cm)	2.0
DUN14 (inner)	15410288534364
Units per outer package	10
Packaging outer length / height (cm)	31.5
Packaging outer width (cm)	22.5
Packaging outer depth (cm)	31.5