

START Highbay IP65 1-10V 26000lm 840 WB

Item No: 0039349

SYLVANIA

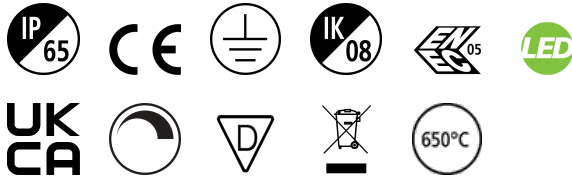

START Highbay, includes 1 m cables, black aluminium housing, 26,000 Lm, 200 W, 130 Lm/W, 4000 K, drive current: 5000 mA, CRI 80, 90° beam angle, 1-10 V dimmable, IP65, IK08, 54,000 hrs (L80/B50), (D x H) 339 x 194 mm, 1 m mains cable, 1 m control cable, 1.2 m chain length including hooks

Technical Assets

Dimensions (mm)

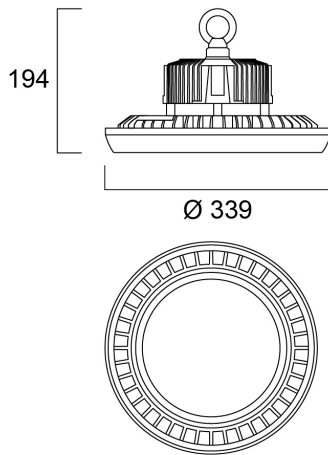

Photometrics

0.5	0.99 0.99	E171 E1C90 44° E1C01 43°	34739 10079 10629
1.0	1.97 1.90	E171 E1C90 44° E1C01 43°	13811 2919 2687
1.5	2.96 2.86	E171 E1C90 44° E1C01 43°	6079 1100 1101
2.0	3.94 3.81	E171 E1C90 44° E1C01 43°	3419 630 664
2.5	4.93 4.76	E171 E1C90 44° E1C01 43°	2188 403 421
3.0	5.92 5.71	E171 E1C90 44° E1C01 43°	1520 280 296

Distance [m] Cone diameter [m] Illuminance [lx]

— C0 - C180 (Half beam angle: 87.2°)
— C90 - C270 (Half beam angle: 89.2°)

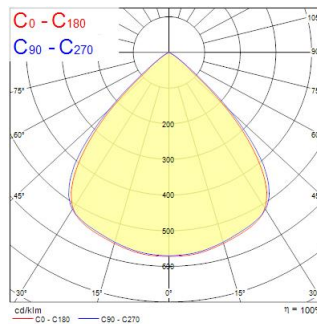

START Highbay IP65 1-10V 26000lm 840 WB

Item No: 0039349

SYLVANIA

General data

Product name	START Highbay IP65 1-10V 26000lm 840 WB
Technology	LED
Housing	Aluminium
Mount	Suspended
Fixture rating	Enclosed
General application	Logistics & Industry
Operating temperature range (°C)	-30°C...+50°C
Performance ambient temperature Tq (°C)	25
ETIM Class	EC001716
E-number FI	4306963
E-number SE	7214417
Warranty	5 years

Optical data

Fixture luminous flux (lm)	26000
Luminaire efficacy (lm/W)	130
Correlated colour temperature (k)	4000
Light colour	Neutral White
CRI (Ra)	80
Colour Variation Initial (SDCM)	SDCM6
Beam Angle (°)	90
Glare control	< 25
Photobiological Risk Group	RG1

Electrical data

Total power consumption (W)	200
Lamp power factor	0.95
THD (at 230 V, 50 Hz, full load, at 100% dimming level) ≤ xx.x %	10
Electrical protection	Class I
Control gear type	Other
Dimmable	Yes
Dimming method	1-10V (Analogue)
Minimum dimming level (%)	1
Drive current (mA)	5000
Inrush Current (A)	60
Inrush Duration (µs)	300
Nominal Frequency (Hz)	50/60Hz
LED Flickering Rate	Ultra low (5% or less)
Max. products per 10A C Breaker	6
Max. products per 13A C Breaker	8
Max. products per 16A C Breaker	9
Max. products per 20A C Breaker	10
Max. products per 10A B Breaker	3
Max. products per 13A B Breaker	4
Max. products per 16A B Breaker	5
Max. products per 20A B Breaker	7

Lifetime data

Lifespan L70 B50	54000
Lifespan L70 B20	54000
Lifespan L70 B10	54000
Lifespan L80 B50	54000
Lifespan L80 B20	54000
Lifespan L80 B10	54000
Lifespan L90 B50	54000
Lifespan L90 B20	54000
Lifespan L90 B10	50000

START Highbay IP65 1-10V 26000lm 840 WB

Item No: 0039349



Physical data

Housing colour	Black
IP rating	IP65
IK rating	IK08
Diffuser finish	Transparent
Diffuser material	PC Polycarbonate
Nominal Product Length (mm)	339
Nominal Product Width (mm)	339
Nominal Product Height (mm)	194
Nominal Product Diameter (mm)	339
Weight (kg)	3.7

Packaging

Product EAN number	5410288393490
Packaging single length / height (cm)	40.0
Packaging single width (cm)	40.0
Packaging single depth (cm)	18.7
DUN14 (inner)	05410288393490
Units per outer package	1
Packaging outer length / height (cm)	40.0
Packaging outer width (cm)	40.0
Packaging outer depth (cm)	18.7

Safety data

Glow Wire Test (°C)	650
Optimal operating condition (°C)	-30-50