

YourHome™

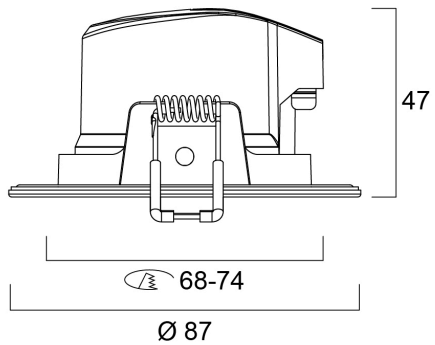

Distance [m]	Cone diameter [m]	Beam diameter [m]	Beam diameter [in]	Illuminance [lx]
0.5	1.33 1.32	Ø171 Ø160 Ø159	Ø11" Ø11" Ø11"	912 998 100
1.0	2.66 2.64	Ø342 Ø320 Ø318	Ø22" Ø21" Ø21"	228 224 20
1.5	4.00 3.97	Ø513 Ø480 Ø477	Ø31" Ø31" Ø31"	151 111 8
2.0	5.33 5.29	Ø684 Ø640 Ø637	Ø41" Ø41" Ø41"	97 68 6
2.5	6.66 6.61	Ø855 Ø800 Ø797	Ø51" Ø51" Ø51"	36 4 4
3.0	7.99 7.93	Ø1026 Ø960 Ø957	Ø61" Ø61" Ø61"	20 1 1

Distance [m] Cone diameter [m] Illuminance [lx]
 — C0 - C180 (Half beam angle: 106.9°)
 — C90 - C270 (Half beam angle: 106.2°)

