

ToLEDo RT BALL V4 CL 470LM 827 E27 SL

Code article 0027248

SYLVANIA



- Perfect for decorative and general lighting applications and creates a warm ambience similar to traditional lamps
- The versatile ToLEDo Retro ball range is the ideal replacement for halogen and incandescent lamps and perfect for chandeliers and decorative applications
- Same look, size and functionality as incandescent lamps
- Omni-directional light distribution
- A++ energy rating
- Gives same sparkling light effect as the incandescent lamp
- Dimensionally identical to incandescent lamps - fits all fixtures
- Environment-friendly - no mercury and lower CO2 emissions

Atouts techniques

Dimensions (mm)

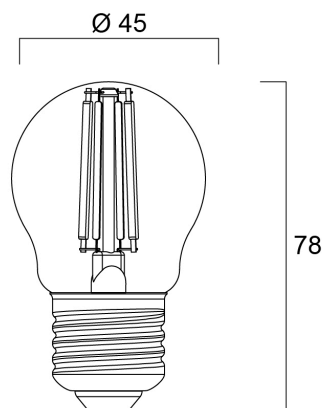

Photométrie

ToLEDo RT BALL V4 CL 470LM 827 E27 SL

Code article 0027248

SYLVANIA

Données générales

Nom du produit	ToLEDo RT BALL V4 CL 470LM 827 E27 SL
Technologie	LED
Puissance (nominale) (W)	4.5
Cap/Base	E27
Fixture rating	Open
General application	Hospitality, Residential & Consumer
Performance ambient temperature Tq (°C)	25
ETIM Class	EC001959
Numéro virtuel FI	4740424
Numéro virtuel SE	8295066
Warranty	3 ans

Données optiques

Useful luminous flux (Φ_{use})	470
Flux lumineux utile (nominal) (lm)	470
Température de couleur (K)	2700
Couleur de lumière	Homelight
IRC (Ra)	80
Beam Angle (°)	300
Maintien du flux à la fin de la durée de vie nominale (lm)	70

Caractéristiques électriques

Power consumption (W)	4.5
Wattage (W)	4.5
Heure de démarrage (max) (s)	0.5
Temps de préchauffage jusqu'à 60 % de la pleine lumière (max) (s)	1
Lamp power factor	0.5
No. Of switching cycles before premature failures	>50000
Courant d'appel (A)	2.6
Nominal Frequency (Hz)	50/60Hz
Max. products per 10A C Breaker	38
Max. products per 16A C Breaker	62
Max. products per 20A C Breaker	77

Durée de vie

Average life (Nominal) (h)	15000
Durée de vie moyenne (nominale) (h)	15000

Données physiques

Longueur (mm)	78
Nominal Product Diameter (mm)	45
Poids (kg)	0.02

Emballage

Product EAN number	5410288272481
Longueur simple de l'emballage (cm)	9.8
Largeur simple de l'emballage (cm)	4.8
Packaging single depth (cm)	4.8
DUN14 (inner)	15410288272488
Units per inner package	6
Packaging inner length / height (cm)	15.3
Packaging inner width (cm)	11.1
Packaging inner depth (cm)	10.6
DUN14 (outer)	25410288272485
Units per outer package	60
Packaging outer length / height (cm)	54.7
Packaging outer width (cm)	33.1
Packaging outer depth (cm)	14.0

Sécurité

Consignes de nettoyage en cas de bris	Not applicable
Lampe à objectif spécial	No
Utilisation pour applications sèches uniquement	Yes
Ne convient pas à l'éclairage résidentiel	Yes
Safety message	Not Suitable for totally enclosed fixtures